

# CONSTRUCTION EQUIPMENT APPLICATION

## MOBILE CRANE

NOTE: These are general recommendations, consult crane manufacturer for correct specifications.

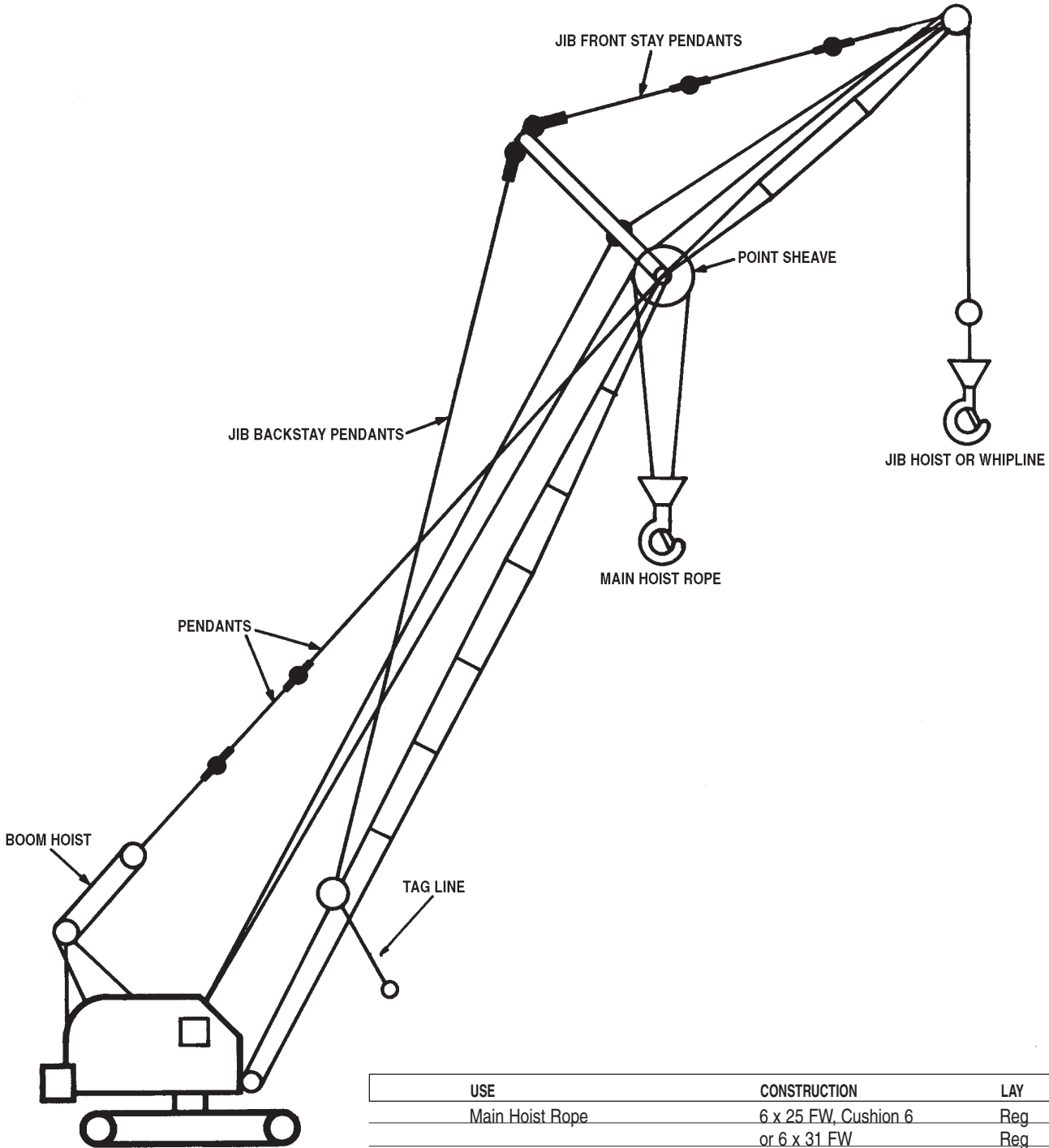

USE	CONSTRUCTION	LAY	CORE
Main Hoist Rope	6 x 25 FW, Cushion 6	Reg	IWRC
	or 6 x 31 FW	Reg	IWRC
Jib Hoist—Single Part Line	18 x 7 (19 x 7)		
	Dy-Pac 18 Rotation Resistant	Reg Reg	IWRC FC or IWRC
Jib Hoist or Whipline—Two Part Line	6 x 25 FW	Reg	IWRC
Boom Hoist	6 x 25 FW	Lang	IWRC
	DyPac	Lang	IWRC
	Cusion Pac-8	Lang	IWRC
Jib Front and Back Stays	6 x 36 WS	Reg	IWRC
Pendants	6 x 36 WS	Reg	IWRC
Tagline	6 x 36 WS	Reg	IWRC

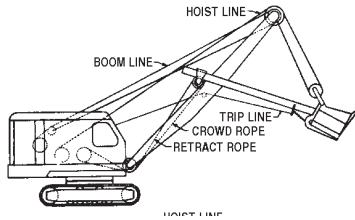

## SHOVEL

F.W.—Filler Wire; WS—Warrington Seale; SWS—Seale Warrington Seale.  
All ropes can be furnished in Powersteel or Yellow Strand.

USE	CONSTRUCTION	LAY	CORE
Hoist Rope 7/8" and Smaller 1" and Larger	6 x 25 F.W. or 6 x 36 WS	Lang or Reg.	IWRC
	6 x 41 F.W. or 6 x 49 SWS		
	Dy-Pac 6 or 6 x 55 SWS	Reg. Lang	IWRC IWRC
Shovel Crowd and Retract 7/8" and Smaller 1" and Larger	6 x 25 F.W. or 6 x 36 WS	Lang	IWRC
	6 x 41 F.W. or 6 x 49 SWS		
	Dy-Pac 6 or 6 x 55 SWS	Reg. Lang	IWRC IWRC
Shovel Trip Line	6 x 25 F.W. or 6 x 36 WS	Reg.	IWRC
Boom Hoist Rope	6 x 25 F.W. or	Reg.	IWRC
	Dy-Pac 6	Reg.	IWRC
	6 x 30 Flattened Strand	Lang	IWRC

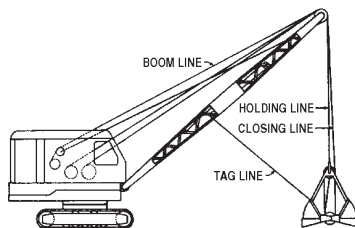

## CLAMSHELL

F.W.—Filler Wire; WS—Warrington Seale; SWS—Seale Warrington Seale.  
All ropes can be furnished in Powersteel or Yellow Strand.

USE	CONSTRUCTION	LAY	CORE
Closing and Holding Lines	6 x 25 F.W. or 6 x 36 WS	Lang or Reg.	IWRC
	Dy-Pac 6	Reg.	IWRC
	6 x 30 Flattened Strand	Lang	or F.C.
Boom Hoist Rope	6 x 25 F.W.	Reg.	IWRC
	Dy-Pac 6	Reg.	IWRC
	6 x 30 Flattened Strand	Lang	IWRC
Tag Line	6 x 25 F.W. or 6 x 36 WS	Reg.	IWRC

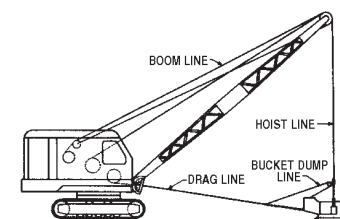

## DRAGLINE

F.W.—Filler Wire; WS—Warrington Seale; SWS—Seale Warrington Seale.  
All ropes can be furnished in Powersteel or Yellow Strand.

USE	CONSTRUCTION	LAY	CORE	
Drag Rope	1/2"-1-4/8"	Lang	IWRC	
	1-1/2"-2-1/2"			
	205/8"-3-1/2"	6 x 21 F.W. or 6 x 25 F.W.	Lang	IWRC
		6 x 30 Flattened Strand or 6 x 55 SWS	Lang	IWRC
Hoist Rope	7/8" and Smaller	6 x 25 F.W. or 6 x 36 WS	Lang or Reg.	IWRC
		Dy-Pac 6	Reg.	IWRC
	1" and Larger	6 x 41 F.W. or 6 x 49 SWS	Reg.	IWRC
		Dy-Pac 6		
		or 6 x 55 SWS	Lang	IWRC
Boom Hoist Rope	6 x 25 F.W.	Reg.	IWRC	
	Dy-Pac 6	Reg.	IWRC	
	6 x 30 Flattened Strand	Lang	IWRC	
Bucket Dump Line	6 x 25 F.W.	Lang or Reg.	IWRC	

# FEATURES FOR CONSIDERATION IN WIRE ROPE SELECTION

## EACH CHARACTERISTIC AFFECTS OTHER CHARACTERISTICS

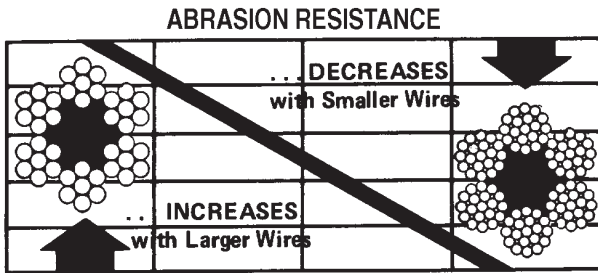

Every wire rope has its own "personality" which is a reflection of its engineered design. Each rope construction has been established to produce a desired combination of operating characteristics which will best meet the performance requirements of the work, or application, for which that design is intended . . . and each rope construction is, therefore, a design compromise.

The best illustration of a design compromise—or best combination of desired characteristics—is the inter-relationship between resistance to abrasion and fatigue resistance.

Fatigue resistance (a rope's capability to bend repeatedly under stress) is accomplished by using many wires in the rope strands. Resistance to metal loss through abrasion is achieved primarily with a rope design which uses fewer and therefore larger wires in the outer layer to reduce the effects of surface wear.

Therefore, from a design standpoint when anything is done to alter either abrasion resistance or fatigue resistance, both of these features will be affected.

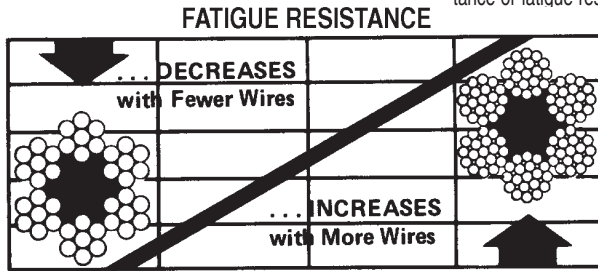

### 1. STRENGTH

Wire rope strength is usually measured in tons of 2,000 pounds. In published material wire rope strength is shown as "nominal" strength. Nominal strength refers to calculated strength figures that have been accepted by the wire rope industry.

When placed under tension on a test device a new rope should break at a figure equal to, or higher than, the nominal strength shown for that rope.

To account for variables which might exist when such tests are made to determine the breaking strength of a new wire rope an "acceptance" strength may be used. The acceptance strength is 2-1/2% lower than the nominal strength and all ropes must meet or exceed this strength.

The nominal strength applies to new, unused rope. A rope should never operate at, or near, the nominal strength. During its useful life, a rope loses strength gradually due to natural causes such as surface wear and metal

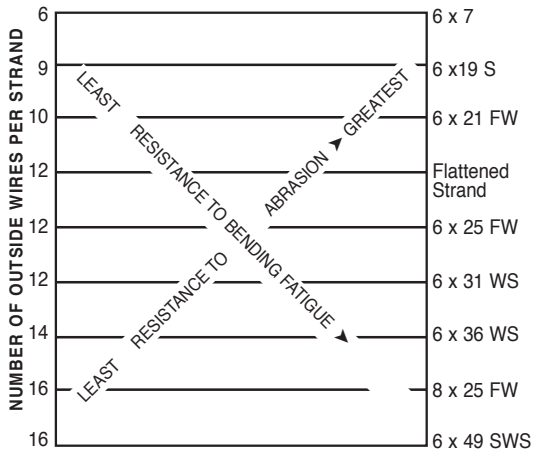

The wire rope industry refers to this as the X-chart. It serves to illustrate the inverse relationship between abrasion resistance and resistance to bending fatigue in a representative number of the most widely used wire ropes.

### 2. RESERVE STRENGTH

The Reserve Strength of a standard rope is a relationship between the strength represented by all the wires in the outer strands and the wires remaining in the outer strands with the outer layer of wires removed. Reserve strength is calculated using actual metallic areas of the individual wires. Since there is a direct relationship between metallic area and strength, Reserve Strength is usually expressed as a percentage of the rope's nominal strength. Reserve Strength is used as a relative comparison between the internal wire load bearing capabilities of different rope constructions.

Reserve Strength is an important consideration in selection, inspection and evaluation of a rope for applications where the consequences of a rope failure are great. The use of Reserve Strength is premised on the theory that the outer wires of the strands are the first to be subjected to damage or wear. Therefore, the Reserve Strength figures are less significant when the rope is subjected to internal wear, damage, abuse, corrosion or distortion.

The more wires there are in the outer layer of a strand construction, the greater will be the rope's Reserve Strength. Geometrically, as more wires are required in the outer layer of a strand, they must be smaller in diameter. This results in greater metallic area remaining to be filled by the inner wires.

Separate columns are shown for standard Fiber Core and IWRC ropes. For Fiber Core ropes, the Reserve Strength is the approximate percentage of the rope's metallic area made up by the inner wires of the outer strands. An IWRC in a rope is considered to contribute 7-1/2% to the rope's total strength. By definition, the core is not included in the Reserve Strength calculation so a 7-1/2% reduction has been made for ropes with an IWRC.

Rotation Resistant ropes, due to their construction, can experience different modes of wear and failure than standard ropes. Therefore, their Reserve Strength is calculated differently. For Rotation Resistant ropes, the Reserve Strength is based on the percentage of the metallic area represented by the core strand plus the inner wires of the strands of both the outer and inner layers.

### RESERVE STRENGTH OF STANDARD ROPES

ROPE CONSTRUCTION	PERCENT OF NOMINAL STRENGTH REPRESENTED BY INNER WIRES OF OUTER STRANDS	
	FIBER CORE	IWRC
6 x 7	17	—
6 x 19 S	32	30
6 x 19 2 OP	40	37
6 x 19 W	42	39
6 x 21 FW	36	33
6 x 25 FW	43	40
6 x 26 WS	36	33
6 x 30 Style G	26	24
6 x 31 WS	43	40
6 x 33 2 OP	44	41
6 x 36 WS	48	44
6 x 37 2 OP	56	52
6 x 41 SFW	53	49
6 x 49 SWS	53	49

### RESERVE STRENGTH OF ROTATION RESISTANT ROPES

ROPE CONSTRUCTION	PERCENT OF NOMINAL STRENGTH REPRESENTED BY INNER WIRES OF STRANDS OF INNER AND OUTER LAYERS	
	8 x 25 Resistwist	38
19 x 7	23	

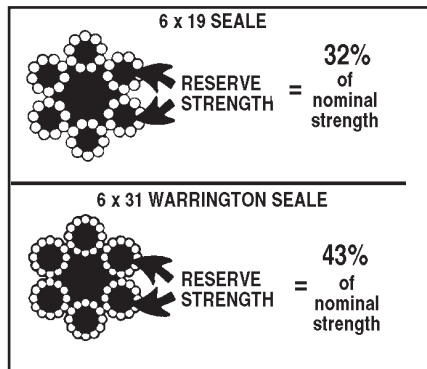

# FEATURES FOR CONSIDERATION IN WIRE ROPE SELECTION

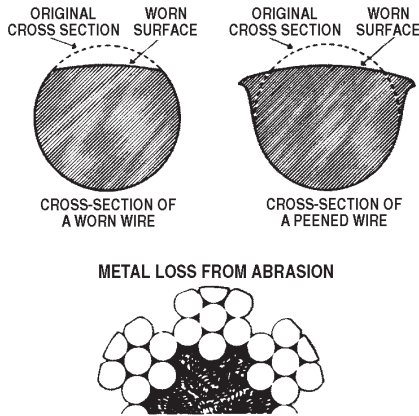

## 3. RESISTANCE TO METAL LOSS AND DEFORMATION

Metal loss refers to the actual wearing away of metal from the outer wires of a rope, and metal deformation is the changing of the shape of outer wires of a rope.

In general, resistance to metal loss by abrasion (usually called "abrasion resistance") refers to a rope's ability to withstand metal being worn away along its exterior. This reduces strength of a rope.

The most common form of metal deformation is generally called "peening" - since outside wires of a peened rope appear to have been "hammered" along their exposed surface.

Peening usually occurs on drums, caused by rope-to-rope contact during take-up of the rope on the drum. It may also occur on sheaves.

Peening causes metal fatigue, which in turn may cause wire failure. The "hammering" which causes metal of the wire to flow into a new shape, realigns the grain structure of the metal, thereby affecting its fatigue resistance. The out-of-round shape also impairs wire movement when the rope bends.

## 4. CRUSHING RESISTANCE

Crushing is the effect of external pressure on a rope, which damages it by distorting the cross-section shape of the rope, its strands or core — or all three.

Crushing resistance therefore is ability to withstand or resist external forces, and is a term generally used to express comparison between ropes. When a rope is damaged by crushing, the wires, strands and core are prevented from moving and adjusting normally in operation. In a general sense, IWRC ropes are more crush resistant than fiber core ropes . . . Lang Lay ropes are less crush resistant than Regular Lay ropes . . . and 6-strand ropes have greater crush resistance than 8-strand ropes.

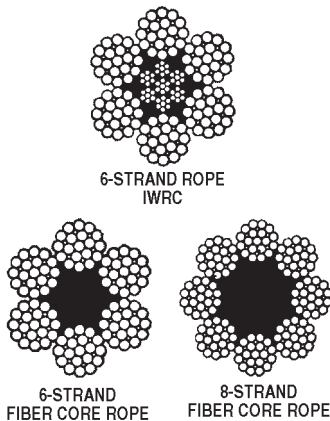

## 5. FATIGUE RESISTANCE

Fatigue resistance involves metal fatigue of the wires that make up a rope. To have high fatigue resistance, wires must be capable of bending repeatedly under stress—as when a rope passes over a sheave. Increased fatigue resistance is achieved in a rope design by using a large number of wires. It involves both the basic metallurgy and the diameters of wires.

In general, a rope made of many wires will have greater fatigue resistance than a same-size rope made of fewer larger wires, because smaller wires have greater ability to bend as the rope passes over sheaves or around drums. To overcome the effects of fatigue, ropes must never bend over sheaves or drums with diameter so small as to kink wires or bend them excessively. There are precise recommendations for sheave and drum sizes to properly accommodate all sizes and types of ropes.

Every rope is subject to metal fatigue from bending stress while in operation, and therefore the rope's strength gradually diminishes as the rope is used.

## 6. BEND-ABILITY

Bend-ability relates to the ability of a rope to bend easily in an arc. Four primary factors affect this capability:

1. Diameter of wires that make the rope.
2. Rope and Strand Construction.
3. Metal Composition of wires and finish such as galvanizing.
4. Type of rope core—fiber or IWRC.

Some rope constructions are by nature more bend-able than others. Small ropes are more bend-able than big ones. Fiber core ropes bend more easily than comparable IWRC ropes. As a general rule, ropes made of many wires are more bend-able than same-size ropes made with fewer larger wires.

## 7. STABILITY

The word "stability" is most often used to describe handling and working characteristics of a rope. It is not a precise term, since the idea expressed is to some degree a matter of opinion, and is more nearly a "personality" trait than any other rope feature. For example, a rope is called stable when it spools smoothly on and off a drum . . . or doesn't tend to tangle when a multi-part reeving system is relaxed.

Strand and rope construction contribute most to stability. Preformed rope is usually more stable than nonpreformed, and Lang Lay rope tends to be less stable than Regular Lay. A rope made of simple 7-wire strands will usually be more stable than a more complicated construction with many wires per strand. There is no specific measurement of rope stability.

# WIRE ROPE SELECTION HINTS

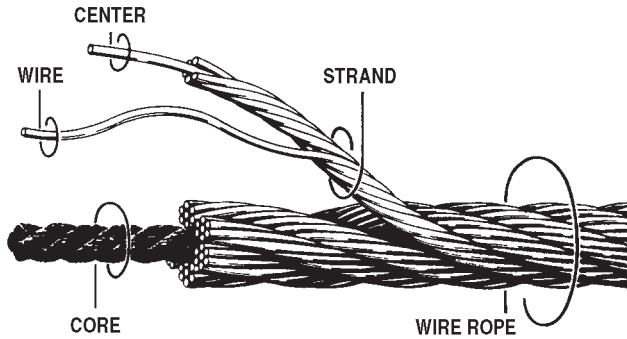

## FOUR PRIMARY FACTORS

Four primary factors affect strength of any wire rope, and must be considered when specifying a rope for an application (1) DIAMETER. (2) TYPE OF CONSTRUCTION. (3) GRADE OF ROPE. (4) CORE.

**DIAMETER** must fit the grooves of sheaves and hoisting drums.

**CONSTRUCTION** includes number of strands, number of wires per strand, and the arrangement of the wires in each strand.

**GRADE OF ROPE** is usually Improved Plow Steel (IPS), or Extra Improved Plow Steel (XIP) which is about 15% stronger than IPS. Specialized Wireco ropes are also available in other grades and types of steel, but IPS and XIP are standards. Ropes may be "Bright"—without special finish for the wire—or Galvanized.

**CORE** is the member of a wire rope about which the strands are laid. It may be fiber, a wire strand, or an independent wire rope.



RIGHT LAY—REGULAR LAY



LEFT LAY—REGULAR LAY



RIGHT LAY—LANG LAY

## MEANING OF LAY

The term "lay" has three meanings 1) Direction strands are "laid" in a rope—right or left. 2) Relationship to the direction wires are "laid" in strands to direction strands are "laid" in the rope—Regular or Lang. 3) A unit of length measure, as illustrated.

In REGULAR lay wires in each strand are rayed opposite the direction the strand is laid in the rope—so exposed portions of wires appear parallel to the length of the rope. Regular lay rope is more stable, resistant to kinks and crushing than Lang lay rope.

In LANG lay exposed wires appear at an angle to the length of the rope. Lang lay rope is more fatigue resistant and resists abrasion better than Regular lay, but has less stability. Lang lay ropes are used on applications where the rope is subjected to repeated bending and both ends are attached so that the rope may not rotate.

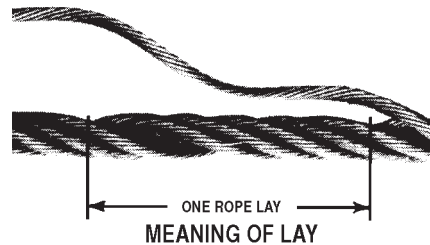

## HOW TO GAUGE WIRE ROPE

Always measure the diameter of any rope at its widest point—by turning the caliper on the rope.

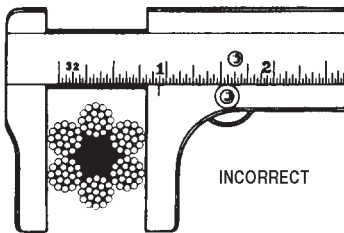
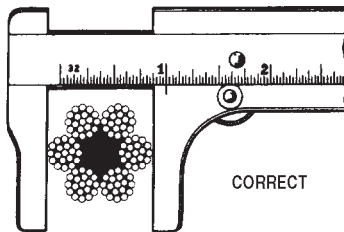

## DESIGN FACTORS

The "catalog" nominal strength figure provided for any wire rope is not to be used as the working load which that rope can repeatedly move without failing before a reasonable amount of service is received. The catalog figure is the strength of a new, un-used wire rope of that specific construction and grade, and is to be considered the actual Breaking Strength. A rope is at its highest strength when it leaves the factory and diminishes gradually with use. Therefore a DESIGN FACTOR must be applied to the catalog strength to determine the load a rope can repeatedly move when the rope is placed in operation. The Design Factor must take into consideration such things as type of service (fast or slow, rough or smooth, sudden stops and starts, etc.), consequences of failure and design of equipment. The following Design Factors are generally accepted in the U.S wire rope industry.

TYPE OF SERVICE	MINIMUM DESIGN FACTOR
Guys	3.5
Track cables	3.2
Haulage ropes	6
Overhead and gantry cranes	6
Jib and pillar cranes	6
Hot ladle cranes.	8
Small electric and air hoists	7
Mine shafts	
for depth to 500'	8
for depth to 500-1000'	7
for depth to 1000-2000'	6
for depth to 2000-3000'	5
for depth to 3000' or more	4
Miscellaneous hoisting equipment	5
Slings	5

## HOW TO EXTEND ROPE SERVICE LIFE

How long will your rope last? There is not a simple answer, but rather, there are several factors involved including: The manner in which you install and “break in” your new rope. The operating technique and work habits of the machine operators. Physical maintenance of the rope throughout its service life. Physical maintenance of the system in which your rope operates.

## RECOMMENDED PRACTICES

We’ve outlined several recommended practices you may use to extend your rope’s useful life. It’s also important to note that all sections of this article, in some respect, also review ways to help you get greater useful life from your rope, and that’s why you need to thoroughly understand all the material here.

## INSTALL YOUR ROPE CORRECTLY

The primary concern when installing a new rope is to not trap any twist in the rope system. Proper handling of the rope from the reel or coil to your equipment will help avoid this situation. Another important step on smooth faced drums is to spool with wraps tight and close together on the first layer. This layer forms the foundation for succeeding layers. Finally, spool the remaining rope on the drum with tension approximating 1% to 2% of the rope’s nominal strength.

## BREAK IN YOUR NEW ROPE PROPERLY

When you install a new operating rope, you should first run it for a brief period of time with no load. Then, for best results, run it under controlled loads and speeds to enable the wires and strands in the rope to adjust to themselves.

## “CONSTRUCTIONAL” STRENGTH

When first put into service, new ropes normally elongate while strands go through a process of seating with one another and with the rope core. This is called “constructional” stretch because it is inherent in the construction of the rope, and the amount of elongation may vary from one rope to another. For standard ropes, this stretch will be about 1/4% to 1% of the rope’s length.

When constructional stretch needs to be minimized, ropes may be factory prestretched. Please specify when placing your order. Another type of stretch, “elastic” stretch, results from recoverable deformation of the metal itself. For more information, please refer to the *Wire Rope Technical Data Handbook*.

## CUT OFF ENDS TO MOVE WEAR POINTS

If you observe wear developing in a localized area, it may be beneficial to cut off short lengths of rope. This may require an original length slightly longer than you normally use. When severe abrasion or numerous fatigue breaks occur near one end or at any one concentrated area—such as drag ropes on draglines or closing lines in clamshell buckets, for example—the movement of this worn section can prolong rope life.

Wire breaks from vibration fatigue occur at end terminations, so short lengths cut off there with reattachment of the socket may prolong the rope’s life. When broken wires are found, you should cut off sections of rope. In the case of a socket, you should cut off at least five or six feet. In the case of clips or clamps, you should cut off the entire length covered by them.

Where there is an equalizing sheave, such as that found in many overhead cranes, fatigue is localized at rope tangency points to the equalizing sheave. Rope life will be increased if you shift this point by cutting off a short length at the end of one of the drums. Be sure to make this cutoff before significant wear occurs at the equalizing sheave, and always do so at the same drum.

## REVERSING ENDS

Frequently, the most severe deterioration occurs at a point too far from the end or is too long to allow the worn section to be cut off. In such cases, you may turn the rope end for end to bring a less worn section into the area where conditions are most damaging. This practice is beneficial for incline rope and draglines. The change must be made well before the wear reaches the removal criteria. When changing ends, be careful to avoid kinking or otherwise damaging the rope.

## CLEAN AND LUBRICATE REGULARLY TO REDUCE WEAR

We lubricate our wire rope during manufacture so that the strands—as well as the individual wires in the strands—may move and adjust as the rope moves and bends. But no wire rope can be lubricated sufficiently during manufacture to last its entire life. That's why it's important to lubricate periodically throughout the life of the rope.

The surface of some ropes may become covered with dirt, rock dust or other material during their operation. This can prevent field-applied lubricants from properly penetrating into the rope, so it's a good practice to clean these ropes before you lubricate them.

The lubricant you apply should be light-bodied enough to penetrate to the rope's core. You normally apply lubricant by using one of three methods: drip it on rope, spray it on or brush it on. In all cases, you should apply it at a place where the rope is bending such as around a sheave. We recommend you apply it at the top of the bend because that's where the rope's strands are spread by bending and more easily penetrated. In addition, there are pressure lubricators available commercially. Your rope's service life will be directly proportional to the effectiveness of the method you use and the amount of lubricant that reaches the rope's working parts.

A proper lubricant must reduce friction, protect against corrosion and adhere to every wire. It should also be pliable and not crack or separate when cold—yet not drip when warm. Never apply heavy grease to the rope because it can trap excessive grit, which can damage the rope. Nor should you apply used "engine oil" because it contains materials that can damage the rope. For unusual conditions, you can specify special lubricants that we can apply at the factory.

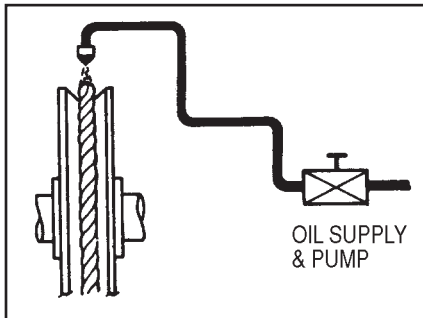

## CONTINUOUS DRIP/SPRAY METHOD

This method is for applying lubricant automatically during machine operation.



## MANUAL SPRAY AND BRUSH-ON METHOD

These methods are generally best accomplished at a sheave where strands are opened up, allowing lubricant to penetrate to the core.

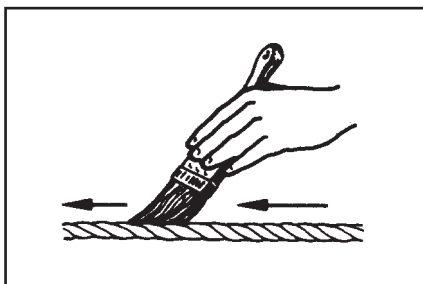

## CLEAN ROPE BEFORE LUBRICATING

Prior to relubricating rope, any large accumulations of grit or other abrasive material should be cleaned off as best as possible. This operation will allow better penetration of the lubricant, and help cut down wear on both the rope and sheaves.

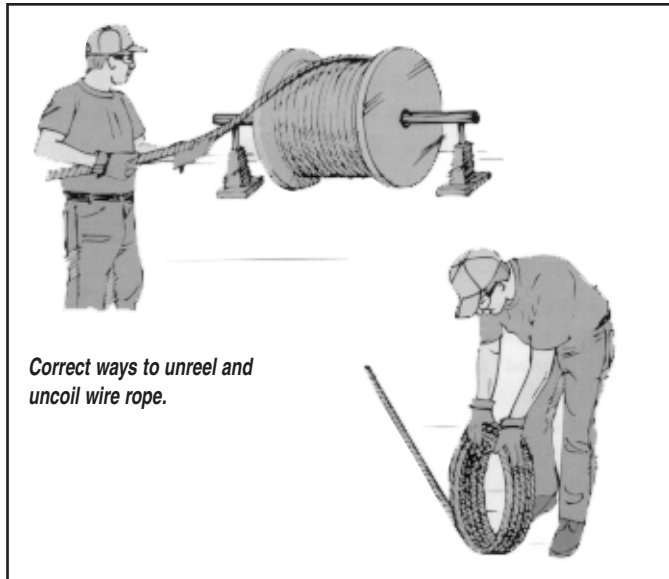

Correct ways to unreel and uncoil wire rope.

## HOW TO UNREEL OR UNCOIL WIRE ROPE

There is always a danger of kinking a wire rope if you improperly unreel or uncoil it. You should mount a reel on jacks or a turntable so that it will revolve as you pull the rope off. Apply sufficient tension by means of a board acting as a brake against the reel flange to keep slack from accumulating. With a coil, stand it on edge and roll it in a straight line away from the free end. You may also place a coil on a revolving stand and pull the rope as you would from a reel or a turntable.

## HOW TO STORE WIRE ROPE PROPERLY

We recommend you store your wire rope under a roof or a weatherproof covering so that moisture cannot reach it. Similarly, you must avoid acid fumes or any other corrosive atmosphere—including ocean spray—in order to protect the rope from rust. If you're storing a reel for a lengthy period, you may want to order your rope with a protective wrap. If not, at least coat the outer layers of rope with a good rope lubricant.

If you ever take a rope out of service and want to store it for future use, you should place it on a reel after you've thoroughly cleaned and relubricated it. Give the same storage considerations to your used rope as you would your new rope.

Be sure to keep your wire rope in storage away from steam or hot water pipes, heated air ducts or any other source of heat that can thin out lubricant and cause it to drain out of your rope.

## WARNING

In the real world, accidents do happen, and that's why you need to take special precautions. Before installing wire rope in your applications, always read and follow the warning label attached to each product.

## THE THREE STAGES OF KINKING



1. **THE START:** A rope should never be allowed to accumulate twist as shown here because it will loop and eventually form a kink. If this loop is removed before being pulled down tight, you can normally avoid the kink.



2. **THE KINK:** By now, the damage is done, and the rope must not be used.



3. **THE RESULT:** Even if the wires do not appear badly damaged, the rope is still damaged and must be replaced. If a twist develops, remove the twist from the rope before a kink can form.

### **WARNING**

Wire rope **WILL FAIL** if worn-out, overloaded, misused, damaged, improperly maintained or abused. Wire rope failure may cause serious injury or death! Protect yourself and others:

- ALWAYS INSPECT wire rope for WEAR, DAMAGE or ABUSE BEFORE USE.
- NEVER USE wire rope that is WORN-OUT, DAMAGED or ABUSED.
- NEVER OVERLOAD a wire rope.
- INFORM YOURSELF: Read and understand manufacturer's literature or "Wire Rope and Wire Rope Sling Safety Bulletin."
- REFER TO APPLICABLE CODES, STANDARDS and REGULATIONS for INSPECTION REQUIREMENTS and REMOVAL CRITERIA.
- For additional information or the *BULLETIN*, ask your employer or wire rope supplier.



## WIRE ROPE INSPECTION

All wire ropes will wear out eventually and gradually lose work capability throughout their service life. That's why periodic inspections are critical. Applicable industry standards such as ASME B30.2 for overhead and gantry cranes or federal regulations such as OSHA refer to specific inspection criteria for varied applications.

## THREE PURPOSES FOR INSPECTION

Regular inspection of wire rope and equipment should be performed for three good reasons:

- It reveals the rope's condition and indicates the need for replacement.
- It can indicate if you're using the most suitable type of rope.
- It makes possible the discovery and correction of faults in equipment or operation that can cause costly accelerated rope wear.

## HOW OFTEN

All wire ropes should be thoroughly inspected at regular intervals. The longer it has been in service or the more severe the service, the more thoroughly and frequently it should be inspected. Be sure to maintain records of each inspection.

## APPOINT A QUALIFIED PERSON TO INSPECT

Inspections should be carried out by a person who has learned through special training or practical experience what to look for and who knows how to judge the importance of any abnormal conditions they may discover. It is the inspector's responsibility to obtain and follow the proper inspection criteria for each application inspected.

For information on inspection methods and techniques ask us for *Techreport 107: Wire Rope Inspection*. If you need further assistance, contact our Product Engineering Department.

## WHAT TO LOOK FOR



Here's what happens when a wire breaks under tensile load exceeding its strength. It's typically recognized by the "cup and cone" appearance at the point of failure. The necking down of the wire at the point of failure to form the cup and cone indicates failure has occurred while the wire retained its ductility.



This is a wire with a distinct **fatigue break**. It's recognized by the **square end** perpendicular to the wire. This break was produced by a torsion machine that's used to measure the ductility. This break is similar to wire failures in the field caused by fatigue.

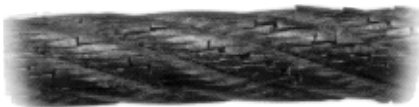

A wire rope that has been subjected to repeated bending over sheaves under normal loads. This results in **fatigue breaks** in individual wires—these breaks are square and usually in the crown of the strands.



An example of **fatigue failure** of a wire rope subjected to heavy loads over small sheaves. The breaks in the valleys of the strands are caused by "strand nicking." There may be crown breaks, too.

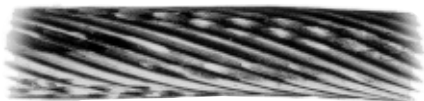

Here you see a single strand removed from a wire rope subjected to "**strand nicking**." This condition is a result of adjacent strands rubbing against one another. While this is normal in a rope's operation, the nicking can be accentuated by high loads, small sheaves or loss of core support. The ultimate result will be individual wire breaks in the valleys of the strands.

## TYPICAL EVIDENCE OF WEAR AND ABUSE



A “**birdcage**” is caused by sudden release of tension and the resulting rebound of rope. These strands and wires will not be returned to their original positions. The rope should be replaced immediately.



A **kinked wire rope** is shown here. It's caused by pulling down a loop in a slack line during handling, installation or operation. Note the distortion of the strands and individual wires. This rope must be replaced.



These wires have been subjected to continued **peening**, causing fatigue type failures. A predetermined, regularly scheduled cutoff practice can help eliminate this type of problem.



Here's a wire rope that has jumped a sheave. The rope “**curled**” as it went over the edge of the sheave. When you study the wires, you'll see two types of breaks here: tensile “cup and cone” breaks and shear breaks that appear to have been cut on an angle.



This is **localized wear** over an equalized sheave. The danger here is that it's invisible during the rope's operation, and that's why you need to inspect this portion of an operating rope regularly. The rope should be pulled off the sheave during inspection and bent to check for broken wires.



**Drum crushing** is caused by small drums, high loads and multiple winding conditions.



This is a wire rope with a **high strand**—a condition in which one or more strands are worn before adjoining strands. This is caused by improper socketing or seizing, kinks or dog-legs. At top, you see a closeup of the concentration of wear. At bottom, you see how it recurs every sixth strand in a 6 strand rope.

## REMOVAL CRITERIA

A major portion of any wire rope inspection is the detection of broken wires. The number and type of broken wires are an indication of the rope's general condition and a benchmark for its replacement.

Frequent inspections and written records help determine the rate at which wires are breaking. Replace the rope when the values given in the table below are reached.

Valley wire breaks—where the wire fractures between strands or a broken wire protrudes between strands—are treated differently than those that occur on the outer surface of the rope. When there is more than one valley break, replace the rope.

Broken wire removal criteria cited in many standards and specifications, like those listed below, apply to wire ropes operating on steel sheaves and drums. For wire ropes operating on sheaves and drums made with material other than steel, please contact the sheave, drum or equipment manufacturer or a qualified person for proper broken wire removal criteria.

## WHEN TO REPLACE WIRE ROPE—BASED ON NUMBER OF WIRES

STANDARD	EQUIPMENT	# OF BROKEN WIRES IN RUNNING ROPES			# OF BROKEN WIRES IN STANDING ROPES	
		IN ONE ROPE LAY	IN ONE STRAND	AT END CONNECTION	IN ONE ROPE LAY	AT END CONNECTION
ASME/B30.2	Overhead and gantry cranes	12**	4	not specified	not specified	not specified
ASME/B30.4	Portal, tower and pillar cranes	6**	3	2	3	2
ASME/B30.5	Mobile and locomotive cranes running ropes	6**	3	2	3	2
ASME/B30.5	Mobile and locomotive cranes rotation-resistant ropes	2 randomly distributed broken wires in 6 rope diameters or 4 randomly distributed broken wires in 30 rope diameters.**				
ASME/B30.6	Derricks	6**	3	2	3	2
ASME/B30.7	Base-mounted drum hoists	6**	3	2	3	2
ASME/B30.8	Floating cranes and derricks	6**	3	2	3	2
ASME/B30.16	Overhead hoists	12**	4	not specified	not specified	not specified
ANSI/A10.4	Personnel hoists	6**	3	2	2**	2
ANSI/A10.5	Material hoists	6**	not specified		not specified	not specified

\*\*Also remove for 1 valley break.

## FLEET ANGLE

The achievement of even winding on a smooth faced drum is closely related to the magnitude of the D/d ratio, the speed of rotation, load on the rope, and the fleet angle. Of all these factors, the one that exerts perhaps the greatest influence on winding characteristics, is the fleet angle.

The schematic drawing (Fig. 34) shows an installation where the wire rope runs from a fixed sheave, over a floating sheave, and then on to the surface of a smooth drum. The fleet angle (Fig. 34) may be defined as the included angle between two lines; one line drawn through the middle of the fixed sheave and the drum—and perpendicular to the axis of the drum and a second line drawn from the flange of the drum to the base of the groove in the sheave. (The drum flange represents the farthest position to which the rope can travel across the drum.) There are left and right fleet angles, measured to the left or right of the center line of the sheave, respectively.

It is necessary to restrict the fleet angle on installations where wire rope passes over the lead or fixed sheave and onto a drum. For optimum efficiency and service characteristics, the angle here should not exceed  $1\frac{1}{2}^\circ$  for a smooth drum, nor  $2^\circ$  for a grooved drum. Fleet angles larger than these suggested limits can cause such problems as bad winding on smooth drums, and the rope rubbing against the flanges of the sheave grooves. Larger angles also create situations where there is excessive crushing and abrasion of the rope on the drum. Conversely, small fleet angles—less than  $\frac{1}{2}^\circ$ —should also be avoided since too small an angle will cause the rope to pile up.

## DRUMS—GROOVED

Drums are the means by which power is transmitted to the rope and thence to the object to be moved. For the wire rope to pick up this power efficiently and to transmit it properly to the working end, installation must be carefully controlled.

If the drum is grooved, the winding conditions should be closely supervised to assure adherence to the following recommended procedures:

- 1) The end of the rope must be secured to the drum by such means as will give the end attachment at least as much strength as is specified by the equipment manufacturer.
- 2) Adequate tension must be maintained on the rope while it is being wound so that the winding proceeds under continuous tension.
- 3) The rope must follow the groove.
- 4) There should be at least three dead turns remaining on the drum when the rope is unwound during normal operation. Two dead turns are a mandatory requirement in many codes and standards.

If the wire rope is carelessly wound and, as a result, jumps the grooves, it will be crushed and cut where it crosses from one groove to the other. Another, almost unavoidable problem is created at the drum flange; as the rope climbs to a second layer there is further crushing and the wires receive excessive abrasion. Riser and filler strips may help remedy this condition.

## SHEAVE INSPECTION

Sheaves should be checked for: 1. Correct groove diameter; 2. Roundness or contour to give proper support to the rope; 3. Small holes, cracks, uneven surfaces, or other defects that might be detrimental to the rope 4. Extreme deep wear.

A sheave should also be checked to make sure it turns freely, is properly aligned, has no broken or cracked flanges, and has bearings that work properly. Drums should also be inspected for signs of wear that could damage rope. Plain-faced or smooth drums can develop grooves or impressions that prevent rope from winding properly. Repair by resurfacing the face or replacing the lagging.

Scrubbing will occur if the rope tends to close wind. If the tendency is to open winding, the rope will encounter abnormal abuse as the second layer forces itself down between the open wraps of the first layer on the drum.

Operating with a smooth drum calls for special care. Be sure the rope is always tightly wound and thread layed on the first layer. Any loosening of the line is easily observed as the winding will be bad and the rope will be coming off with a series of "bad spots."

Grooved drums should be examined for tight or corrugated grooves and for differences in depth or pitch that could damage the second and subsequent layers. Worn grooves can develop extremely sharp edges that shave away small particles of steel from the rope. Correct this condition by grinding or filing a radius to replace the sharp edge. Drum flanges, as well as the starter, filler and riser strips, should be checked. Excessive wear here often causes unnecessary rope abuse at the change of layers and cross-over points.

Other places of contact such as rollers, scrub boards, guides and end attachments should also be inspected.

## MEASURE THE WIDEST DIAMETER

Ropes and sheave grooves must be precisely fitted to each other to get the most service out of your wire rope dollar. Make measurement of rope diameter a normal part of your inspection program. There's only one right way to measure rope diameter: use machinist's calipers and be sure to measure the widest diameter. This method is not only useful for measuring the diameter of a new rope, but also for determining the amount of wear and compression that has occurred while the rope has been in use. Accurate recording of this information is essential in helping to decide when to replace wire rope.

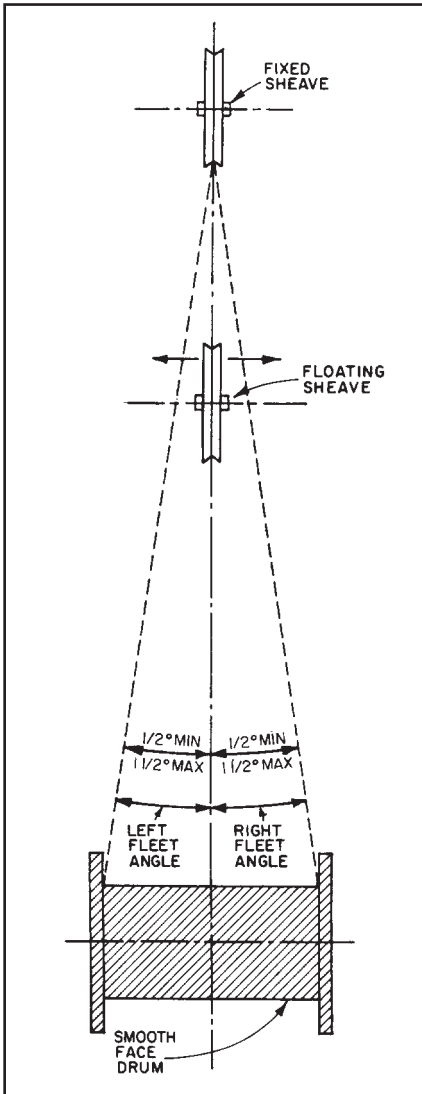

Figure 34. This illustration of wire rope running from a fixed sheave, over a floating sheave, and then on to a smooth drum, graphically defines the fleet angle.

## DRUMS—PLAIN (SMOOTH)

Installation of a wire rope on a plain (smooth) face drum requires a great deal of care. The starting position should be at the drum end so that each turn of the rope will wind tightly against the preceding turn (Fig. 26). Here too, close supervision should be maintained all during installation. This will help make certain that:

- 1) the rope is properly attached to the drum,
- 2) appropriate tension on the rope is maintained as it is wound on the drum,
- 3) each turn is guided as close to the preceding turn as possible, so that there are no gaps between turns,
- 4) and that there are at least two dead turns on the drum when the rope is fully unwound during normal operating cycles.

Loose and uneven winding on a plain- (smooth-) faced drum, can and usually does create excessive wear, crushing and distortion of the rope. The results of such abuse are lower operating performance, and a reduction in the rope's effective strength. Also, for an operation that is sensitive in terms of moving and spotting a load, the operator will encounter control difficulties as the rope will pile up, pull into the pile and fall from the pile to the drum surface. The ensuing shock can break or otherwise damage the rope.

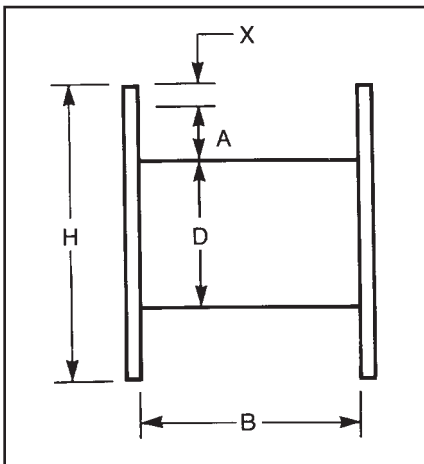
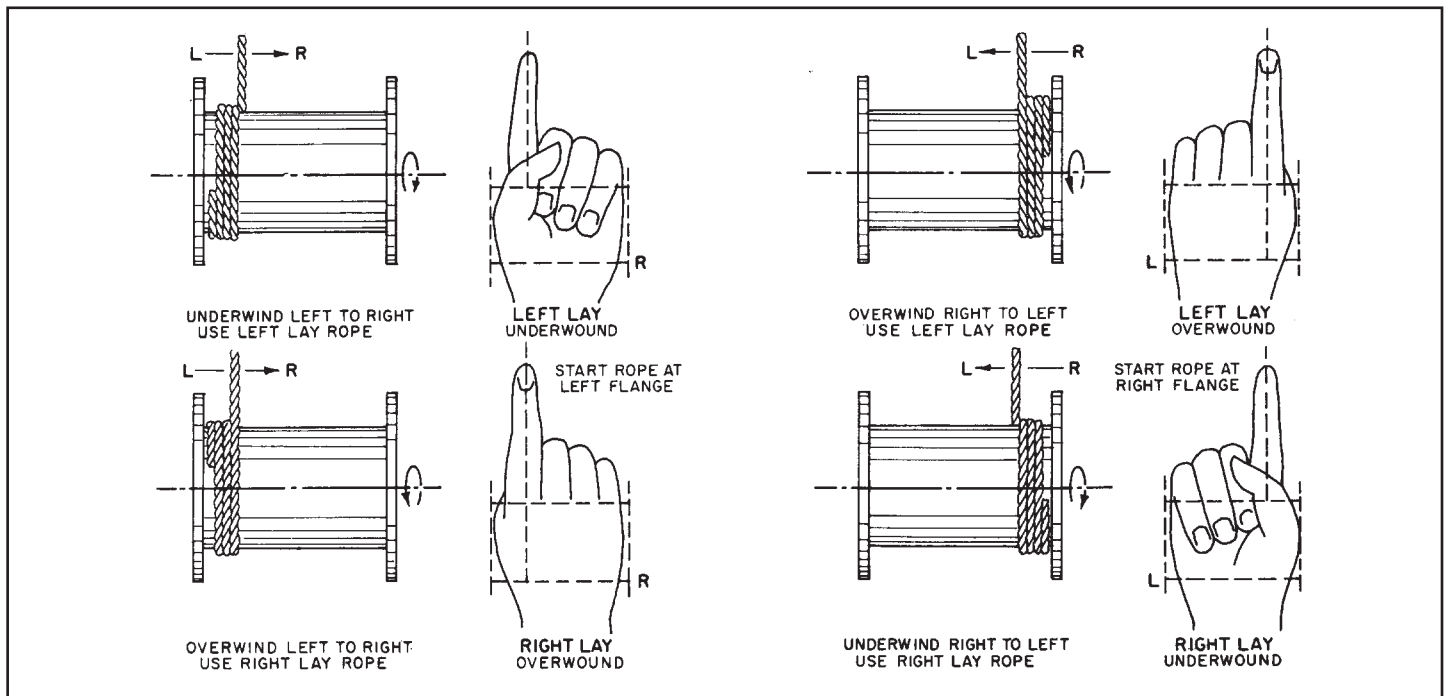

## REEL CAPACITY

It is virtually impossible to calculate the precise length of wire rope that can be spooled on a reel or drum. The formula below provides a sufficiently close approximation based on uniform rope winding on the reel.

$$L = (A + D) \times X \times B \times K$$

L = length of wire rope in fleet  
 A = depth of rope space on reel in inches  
 B = width of drum between flanges in inches  
 D = barrel diameter in inches  
 K = constant for given wire rope diameter (per table below)  
 H = diameter in reel flanges in inches  
 X = clearance

DIAMETER (IN.)	K
1/16	49.8
3/32	23.4
1/8	13.6
5/32	8.72
3/16	6.14
7/32	4.59
1/4	3.29
5/16	2.21
3/8	1.58
7/16	1.19

DIAMETER (IN.)	K
1/2	0.925
9/16	0.741
5/8	0.607
11/16	0.506
3/4	0.428
13/16	0.354
7/8	0.308
1	0.239
1-1/8	0.191
1-1/4	0.152

DIAMETER (IN.)	K
1-3/8	0.127
1-1/2	0.107
1-5/8	0.0886
1-3/4	0.0770
1-7/8	0.0675
2	0.0597
2-1/8	0.0532
2-1/4	0.0476
2-3/8	0.0419
2-1/2	0.0380

# WIRE ROPE DRUMS

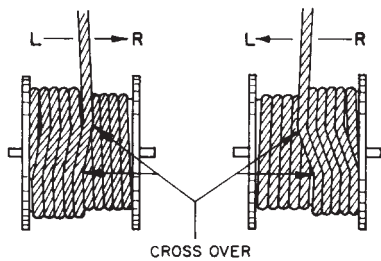

**Figure 27.** After the first layer is wound on a drum, the point at which the rope winds back for each turn is called the cross-over.

The proper direction of winding the first layer on a smooth drum can be determined by standing behind the drum and looking along the path the rope travels, and then following one of the procedures illustrated in Figure 26. The diagrams show: the correct relationship that should be maintained between the direction of lay of the rope (right or left), the direction of rotation of the drum (overwind or underwind), winding from left to right or right to left.

## DRUMS—MULTIPLE LAYERS

Many installations are designed with requirements for winding more than one layer of wire rope on a drum. Winding multiple layers presents some further problems.

The first layer should wind in a smooth, tight helix which, if the drum is grooved, is already established. The grooves allow the operator to work off the face of the drum, and permit the minimum number of dead turns.

A smooth drum presents an additional problem, initially, as the wire rope must be wound in such a manner that the first layer will be smooth and uniform and will provide a firm foundation for the layers of rope that will be wound over it. The first layer of rope on the smooth drum should be wound with tension sufficient to assure a close helix—each turn being wound as close as possible to the preceding turn—and most, if not all, of the entire layer being used as dead turns. The first layer then acts as a helical groove which will guide the successive layers. Unlike wire ropes operating on groove drums, the first layer should not be unwound from a smooth-faced drum with multiple layers.

After the rope has wound completely across the face of the drum (either smooth or grooved), it is forced up to a second layer at the flange. The rope then winds back across the drum in the opposite direction, lying in the depression between the turns of the rope on the first layer. Advancing across the drum on the second layer, the rope, following the "grooves" formed by the rope on the first layer, actually winds back one turn in each revolution of the drum. The rope must then cross two rope "grooves" in order to advance across the drum for each turn. The point at which this occurs is known as the cross-over. Cross-over is unavoidable on the second, and all succeeding layers. Figure 27 illustrates the winding of a rope on the second layer from left to right, and from right to left—the direction is shown by the arrows.

At these cross-over points, the rope is subjected to severe abrasion and crushing as it is pushed over the two rope "grooves" and rides across the crown of the first rope layer. The scrubbing of the rope, as this is happening, can easily be heard.

There is, however, a special drum grooving available that will greatly minimize the damage that can occur at cross-over points.

Severe abrasion can also be reduced by applying the rule for the correct rope lay (right- or left-lay) to the second layer rather than to the first layer. It is for this reason that the first layer of a smooth drum should be wound tight and used as dead turns.

## SIZE OF SHEAVES AND DRUMS

Wire rope is built to transmit power around corners, but it must be guided by sheaves. These sheaves must be properly grooved and of adequate diameter to allow the rope to bend without binding. Drums must also be of adequate diameter to prevent the rope from binding internally. Minimum recommended drum and sheave tread diameters are determined by multiplying the factor in the table below by the nominal rope diameter.

### D / d RATIOS

ROPE CONSTRUCTION	MULTIPLYING FACTOR	
	RECOMMENDED	MINIMUM
6 X 7	72	42
18 X 7	51	33
6 X 19 S	51	33
6 X 21 FW	45	30
6 X 25 FW	39	26
6 X 36 WS	35	22
6 X 41 SFW	32	18
6 X 42 Tiller	21	14
8 x 19 S	34	21
8 x 25 FW	32	20

D = Sheave or Drum Tread Diameter

d = Nominal Wire Rope Diameter

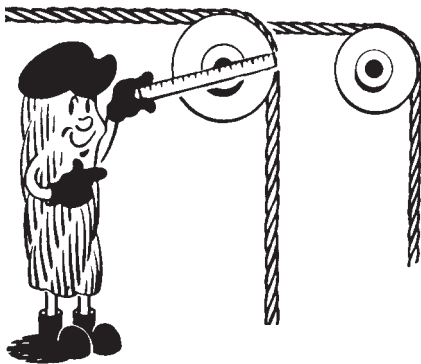

**ALWAYS STAND IN CLEAR VIEW OF YOUR CRANE HOIST ENGINEER.**

**BE SURE TO STAY A SAFE DISTANCE FROM HOOK, BLOCK OR BOOM.**

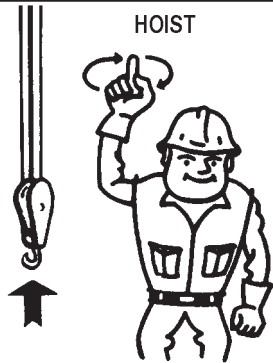

**HOIST:** With forearm vertical, forefinger pointing up, move hand in small horizontal circles.

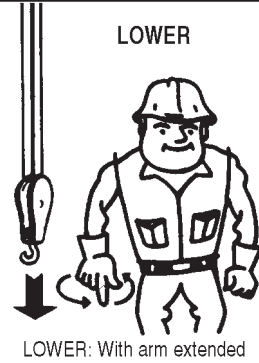

**LOWER:** With arm extended downward, forefinger pointing down, move hand in small horizontal circles.

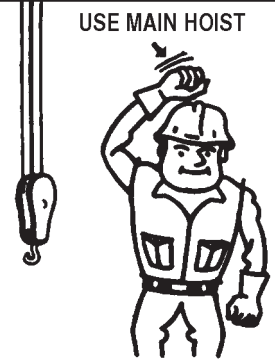

**USE MAIN HOIST:** Tap first on head, then use regular signals.

**USE WHIP LINE**

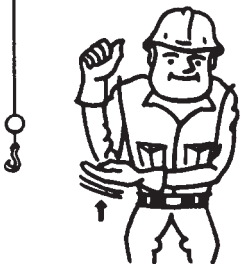

**USE WHIP LINE:** (Auxiliary Hoist). Tap elbow with one hand; then use regular signals.

**RAISE BOOM**

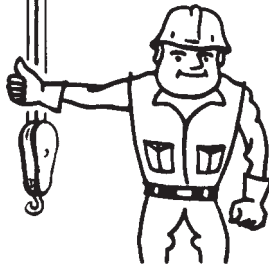

**RAISE BOOM:** Arm extended, fingers closed, thumb pointing upward.

**LOWER BOOM**

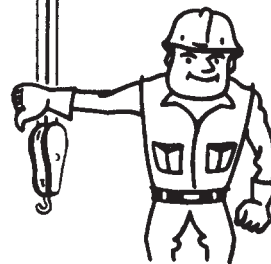

**LOWER BOOM:** Arm extended, fingers closed, thumb pointing downward.

**MOVE SLOWLY**

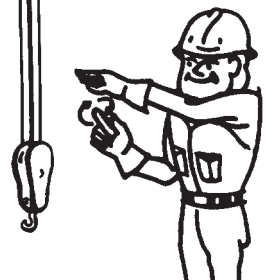

**MOVE SLOWLY:** Use one hand to give any motion signal and place other hand motionless in front of hand giving the motion signal. (Hoist slowly shown as example.)

**RAISE THE BOOM AND LOWER THE LOAD**

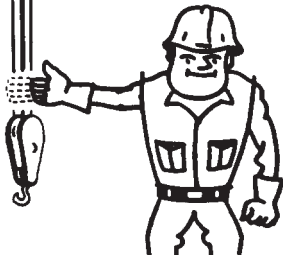

**RAISE THE BOOM AND LOWER THE LOAD:** With arm extended, thumb pointing up, flex fingers in and out as long as load movement is desired.

**LOWER THE BOOM AND RAISE THE LOAD**

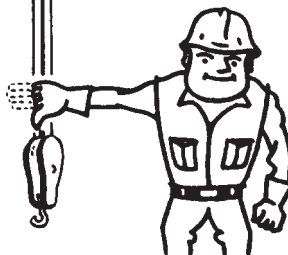

**LOWER THE BOOM AND RAISE THE LOAD:** With arm extended, thumb pointing down, flex fingers in and out as long as load movement is desired.

**SWING**

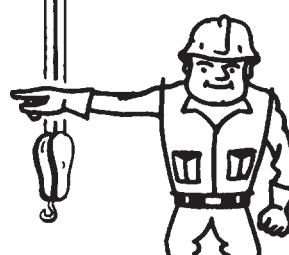

**SWING:** Arm extended, point with finger in direction of swing of boom.

**STOP**

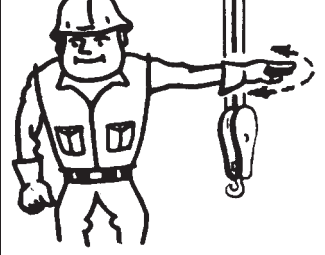

**STOP:** Arm extended, palm down, move arm back and forth horizontally.

**SPANISH CHART AVAILABLE**

**PLEASE CALL**

**EMERGENCY STOP**

**EMERGENCY STOP:** Both arms extended, palms down, move arms back and forth horizontally.

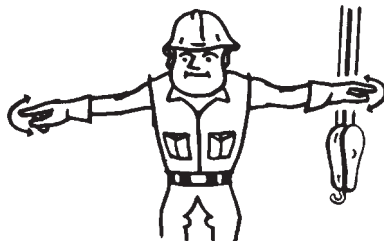

**TRAVEL**

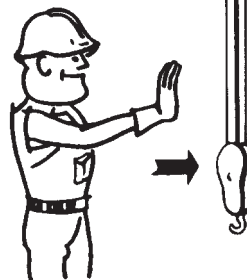

**TRAVEL:** Arm extended forward, hand open and slightly raised, making pushing motion in direction of travel.

**DOG EVERYTHING**

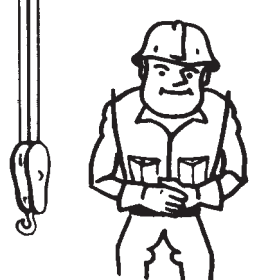

**DOG EVERYTHING:** Clasp hands in front of body.